

Scotsman

Ice Systems

SCHEMA ELETTRICO

ELECTRICAL WIRING DIAGRAM

SDE / SDH 18-24-30-40-50-64-84-100-170

SCH Series

BH-M 2006-2508-3008-3015

BH-M 4015-5022-6022-7540-9550

SQH 35-45-75-125

03	24/0159	LB	02.07.25		DATA	19.01.22	PRIMA PAGINA FIRST PAGE			SQH series BH-M series SDE / SDH / SCH series				230 VAC 50/60 Hz		=
01	24/0085	LB	03.02.25		DISEGN.	L.BOGA								+		
02	25/0073	LB	26.05.25		VISTO	L.RASULO								050578-04		03
REV.	MODIFICA	SG	DATA	FIRMA	APPR.	L.RASULO	SOST. IL :	07.06.23	SOST. DA :	L.RASULO	FILE :	05057843.DWG	050578-04		03	FG. 1
													050578-04		03	F.T. 4

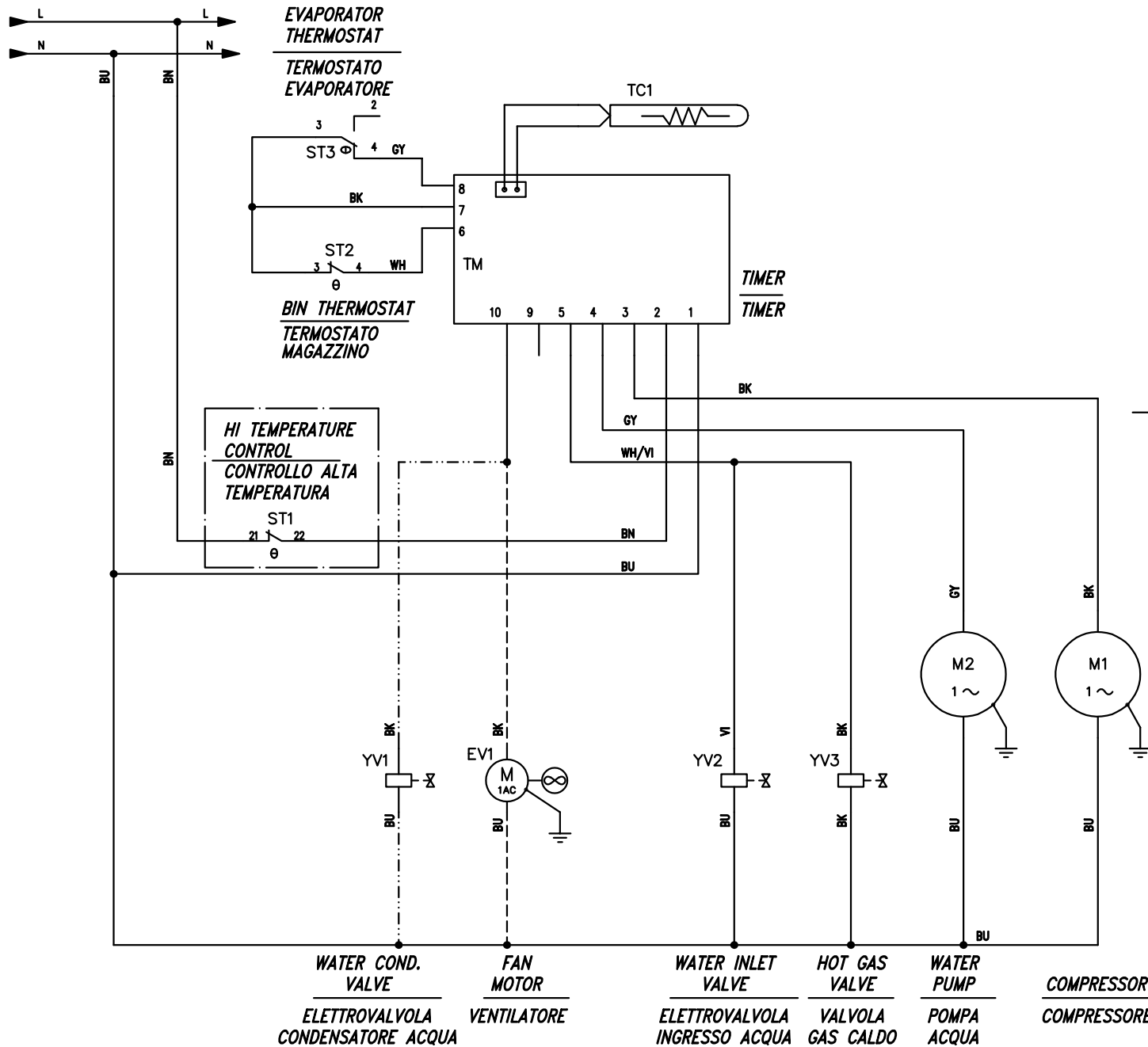

- BK BLACK / NERO
- BN BROWN / MARRONE
- BU BLUE / AZZURRO
- GY GREY / GRIGIO
- GN GREEN / VERDE
- RD RED / ROSSO
- YE YELLOW / GIALLO
- WH WHITE / BIANCO
- OG ORANGE / ARANCIONE
- PK PINK / ROSA
- VI VIOLET / VIOLA











ONLY FOR
 WATER COOLED MODELS
 BH-M 2006-2508-3008-3015
 BH-M 4015-5022-6022
 SOLO PER MODELLI
 RAFFREDDATI AD ACQUA
 BH-M 2006-2508-3008-3015
 BH-M 4015-5022-6022

ONLY FOR
 AIR COOLED MODELS
 SOLO PER MODELLI
 RAFFREDDATI AD ARIA

ONLY FOR
 BH & SCH & SQH &
 SDH 64-84-100-170 MODELS
 SOLO PER MODELLI
 BH & SCH & SQH &
 SDH 64-84-100-170 MODELS

WATER COND. VALVE FAN MOTOR WATER INLET VALVE HOT GAS VALVE WATER PUMP COMPRESSOR
 ELETTROVALVOLA VENTILATORE ELETTROVALVOLA VALVOLA POMPA COMPRESSORE
 CONDENSATORE ACQUA ACQUA INGRESSO ACQUA GAS CALDO ACQUA

03	24/0159	LB	02.07.25	DATA	19.01.22	SCHEMA ELETTRICO ELECTRICAL WIRING DIAGRAM	SQH series BH-M series SDE / SDH / SCH series		230 VAC 50/60 Hz	=					
01	24/0085	LB	03.02.25	DISEGN.	L. BOGA				+						
02	25/0073	LB	26.05.25	VISTO	L. RASULO				03	FG. 2					
REV.	MODIFICA	SG	DATA	FIRMA	APPR.	L. RASULO	SOST. IL :	07.06.23	SOST. DA :	L. RASULO	FILE :	05057843.DWG	050578-04	03	FG. 2

Sim.\Sym	Sigla\Item	Funzione\Use Type	Sim.\Sym	Sigla\Item	Funzione\Use Type	Sim.\Sym	Sigla\Item	Funzione\Use Type
	EV1	Fan motor Ventilatore						
	M1	Compressor Compressore						
	M2	Water pump Pompa acqua						
	ST1	HI Temperature control Controllo alta temperatura						
	ST2	Bin thermostat Termostato magazzino						
	ST3	Evaporator thermostat Termostato evaporatore						
	TC1	Condenser temperature sensor Sensore temperatura condensatore						
	TM	Electronic timer Timer elettronico						
	YV1	Water condenser valve Elettrovalvola acqua condensatore						
	YV2	Water inlet valve Elettrovalvola ingresso acqua						
	YV3	Hot gas valve Elettrovalvola gas caldo						

03	24/0159	LB	02.07.25		DATA	19.01.22
01	24/0085	LB	03.02.25		DISEGN.	L.BOCA
02	25/0073	LB	26.05.25		VISTO	L.RASULO
REV.	MODIFICA	SG	DATA	FIRMA	APPR.	L.RASULO

LEGENDA SIMBOLI
SYMBOLS LEGEND

SQH series
BH-M series
SDE / SDH / SCH series

Scotsman
Ice Systems

230 VAC 50/60 Hz

050578-04

=

+

03
FG. 3
F.T. 4

